

2 1/2" STRAIGHT BODY POLY STORM GUNITE JET (210-3840) INSTALLATION INSTRUCTIONS AND PRESSURE TESTING

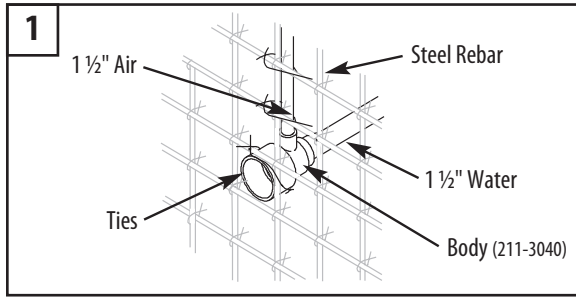

1. Hang Poly Storm Gunite Jet Body with ties through preset holes onto steel rebar.

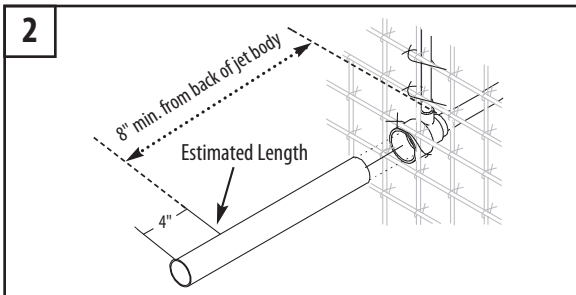

2. Estimate needed length of 2 1/2" PVC pipe by thickness of wall. Cut 2 1/2" PVC pipe at least 4" longer than estimated finish length. Then glue 2 1/2" PVC pipe into body.

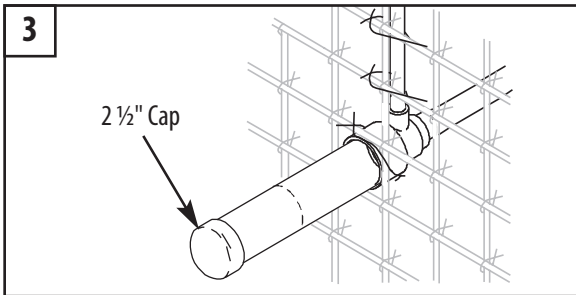

3. Glue 2 1/2" cap onto end of pipe for pressure test, before guniting.

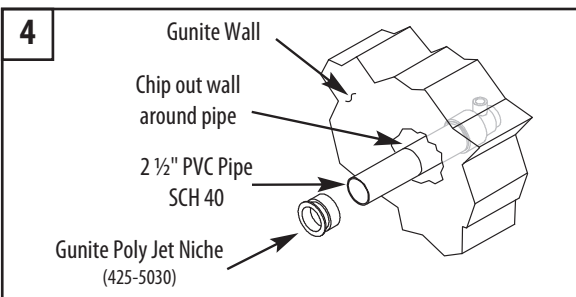

4. While guniting, scoop out gunite around the 2 1/2" PVC pipe, allowing for the plaster niche (425-5030). Before plastering, cut the 2 1/2" pipe so that the plastic niche will fit flush with the finished wall. Glue the plaster niche onto the pipe, then cover the niche with tape for plastering.

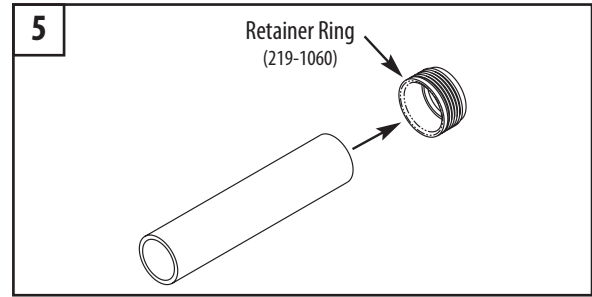

5. Cut a piece of 1" PVC pipe a couple of inches longer than the 2 1/2" pipe and glue the threaded retainer ring to it.

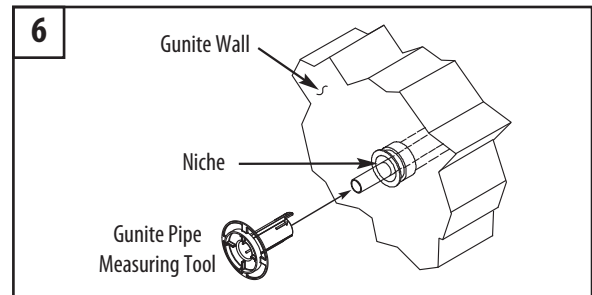

6. Insert 1" PVC pipe assembly through the niche and up to the jet body assembly and thread in. Slide the Gunite Pipe Measuring Tool (218-1890A) over the end of the pipe until flush against the plaster niche.

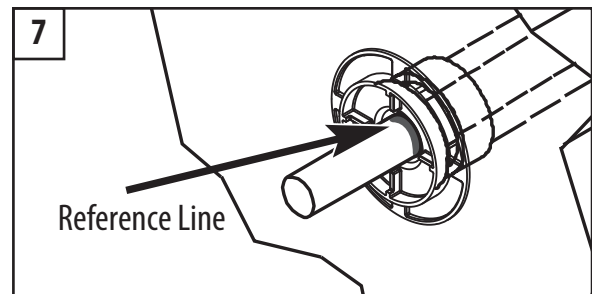

7. Draw a reference line on the 1" PVC pipe, flush with the back edge of the measuring tool.

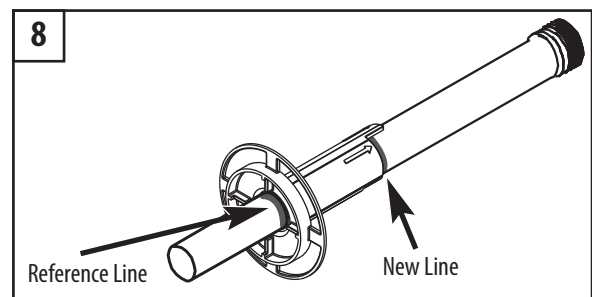

8. Remove the 1" pipe assembly from the jet body assembly and realign the measuring tool with the reference line. Make a new line at the Poly Storm Gunite Jet setback on the measuring tool.



2200 East Sturgis Road, Oxnard CA 93030 • Phone 805.981.0262 • Fax 805.981.9403

www.waterwayplastics.com • waterway@waterwayplastics.com

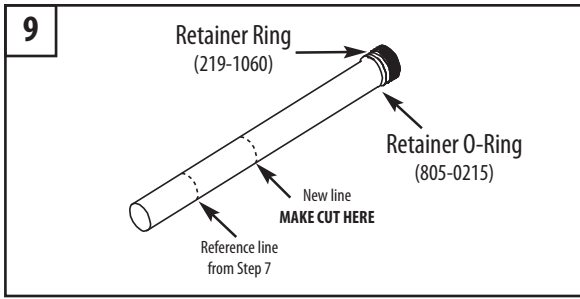

9. At the new line drawn from the setback, cut the pipe.

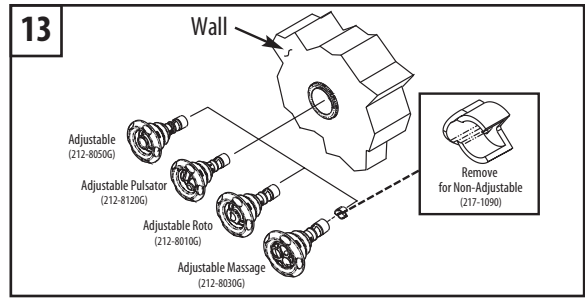

13. Always use at least one non-adjustable internal per spa to prevent deadheading pump.

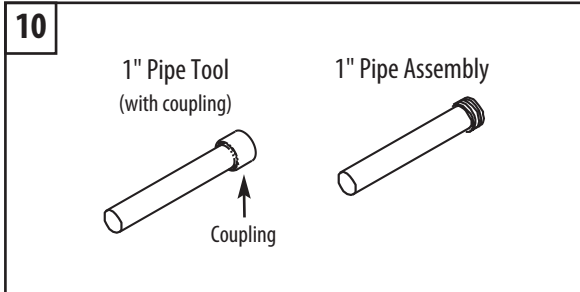

10. Create a 1" pipe tool with coupling attached to install the pipe assembly in the following steps.

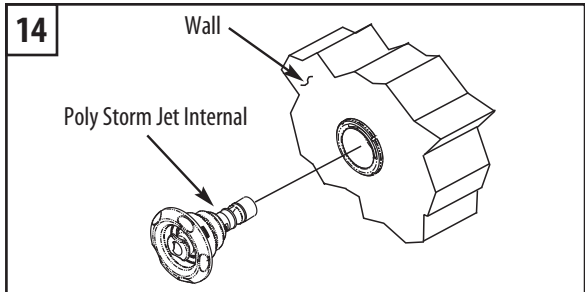

14. Align tab behind escutcheon face on jet internal with slot on wall fitting. Location of slot and tab are shown below. Push Poly Storm internal into wall fitting until it snaps into place. To reduce water flow, turn clockwise. To increase water flow, turn counter-clockwise until it stops turning. To remove, continue turning counter-clockwise past stopping point. You will hear a snap to confirm release of Poly Storm internal.

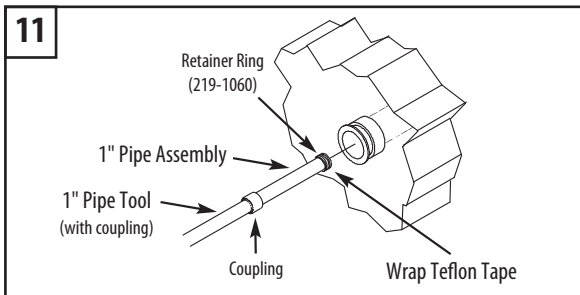

11. Install 4-6 wraps of Teflon tape around the threaded Retainer Ring, including 1 wrap over the O-Ring. Dry fit the pipe tool with coupling on the end of the 1" pipe assembly. Thread the assembly into the body assembly until it is snug and the pipe tool with coupling spins freely. Remove the pipe tool from the end of the pipe assembly.

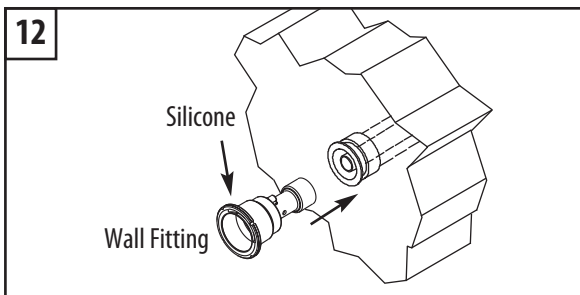
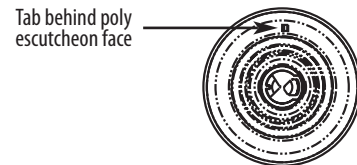

12. Put a bead of clear silicone sealant all around the back side of the wall fitting's flange. Prime and cement the end of the 1" pipe and fitting socket. Slide fitting onto end of 1" pipe until tight against the plaster niche.

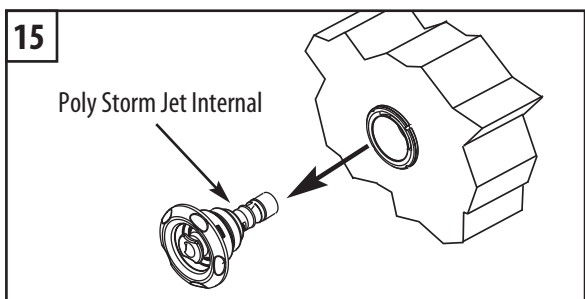

15. To winterize the jet system, remove the jet internal from the wall fitting ONLY. Install a #10 rubber expansion plug inside of the fitting opening.



To prevent personal injury, shock, or property/equipment damage, an Air Spring Check Valve (2" 600-8160, 1 1/2" 600-8140) must be installed on the blower stand pipe in case of a water backup in the air line.

NOTE: If a blower is not being used, please direct the air intake toward the ground using the 2" Sweep Vent Grate Assembly (400-4130) on the Air Inlet Pipe.

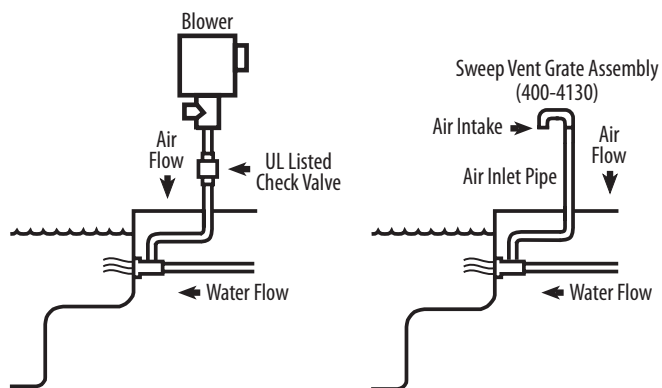
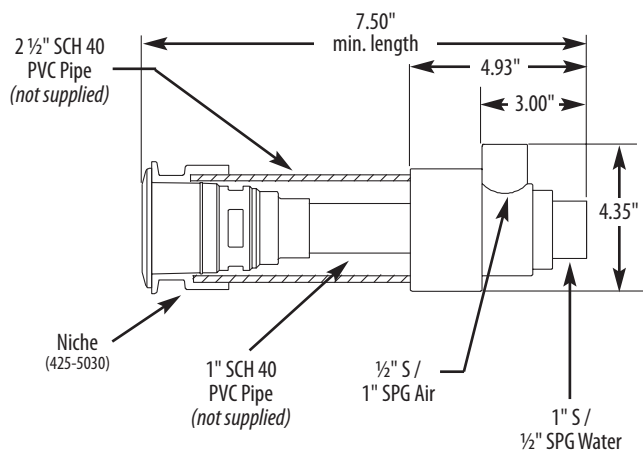

POLY STORM JET INTERNALS AND ACCESSORIES



Always use at least one Non-Adjustable internal per spa to prevent deadheading pump.

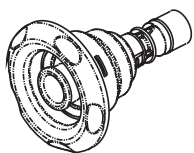

Large Volume
212-8040G - White
17-20 GPM

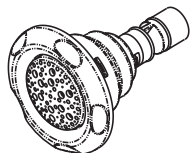

Galaxy
212-8190G - White
10 GPM

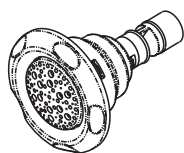

Galaxy Massage
212-8530G - White
10 GPM

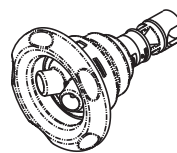

Power Storm II
212-8250G - White
10 GPM

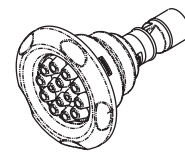

Multi Massage
212-8270G - White
10 GPM

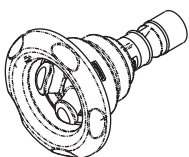

Twin Roto
212-8120G - White
10 GPM

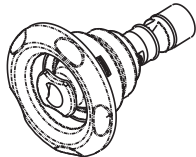

Roto
212-8010G - White
10 GPM

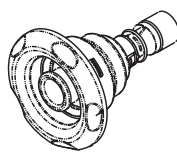

Directional
212-8050G - White
10 GPM

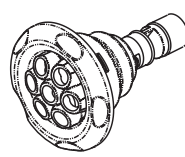

Massage (7 Nozzle)
212-8030G - White
10 GPM

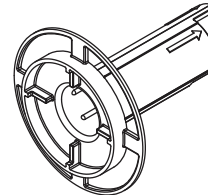

Wrench
218-1890A

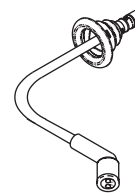

Handheld Jet
210-3250
10 GPM

WARRANTY

For product registration visit: www.waterwayplastics.com.

For Warranty questions or claims please contact point of purchase.