

2 1/2" POLY GUNITE JET (210-3700) INSTALLATION INSTRUCTIONS AND PRESSURE TESTING

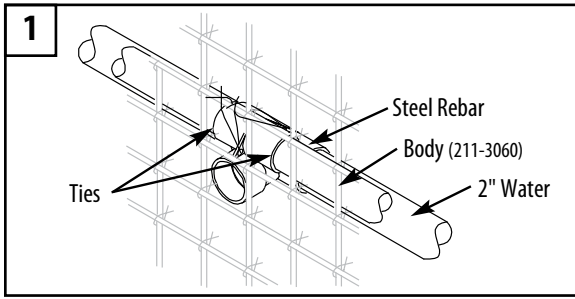

1. Hang Gunite Poly Jet Body with ties through preset holes onto steel rebar.

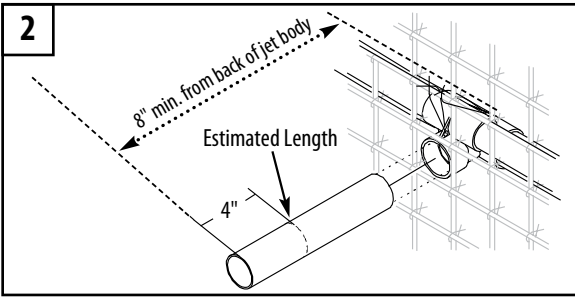

2. Estimate needed length of 2 1/2" PVC pipe by thickness of wall. Cut 2 1/2" PVC pipe at least 4" longer than estimated. Then glue 2 1/2" PVC pipe to body.

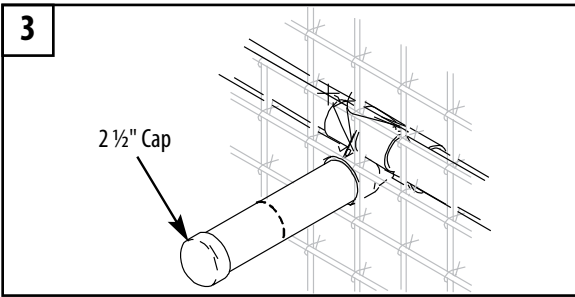

3. Glue 2 1/2" cap onto end of pipe for pressure test being guniting.

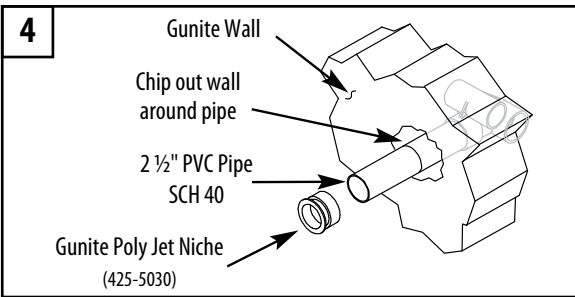

4. After pool guniting, scoop around the pipe. Before plastering, cut the 2 1/2" PVC pipe inside the wall and glue on the Gunite Poly Jet Plaster Niche (425-5030) (not included). Cover niche and tape then plaster over niche.

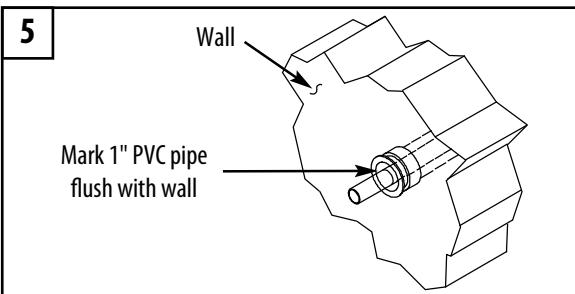

5. Make a mark on the 1" PVC pipe flush or even with the end of the 2 1/2" pipe.

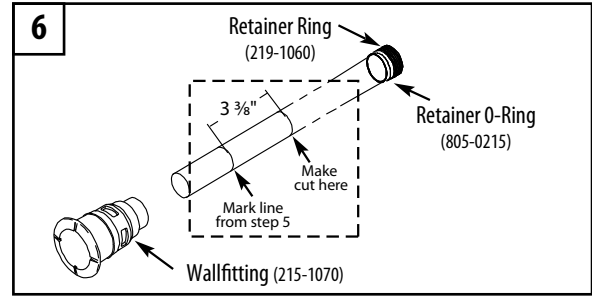

6. Unscrew 1" PVC pipe from body and cut 3 3/8" inward from the mark towards retainer ring, then glue wallfitting to 1" PVC pipe.

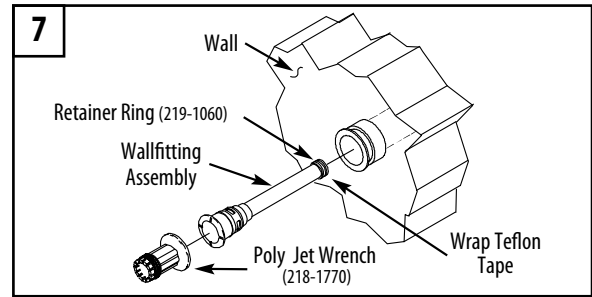

7. Wrap Teflon tape on retainer ring if necessary and thread the 1" PVC pipe back into body with Poly Jet Wrench, making sure of a snug fit.

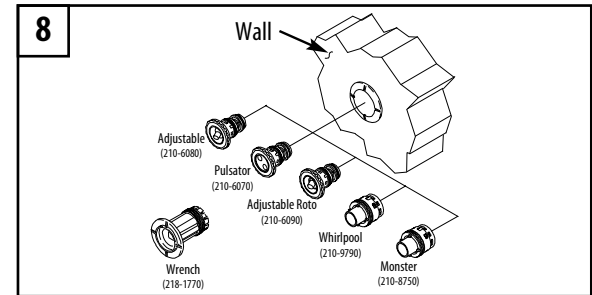

8. If installing any of the internals above, use a Poly Jet Wrench to screw internal into wallfitting. Also available are metal escutcheons to cover plastic wallfittings (see below).

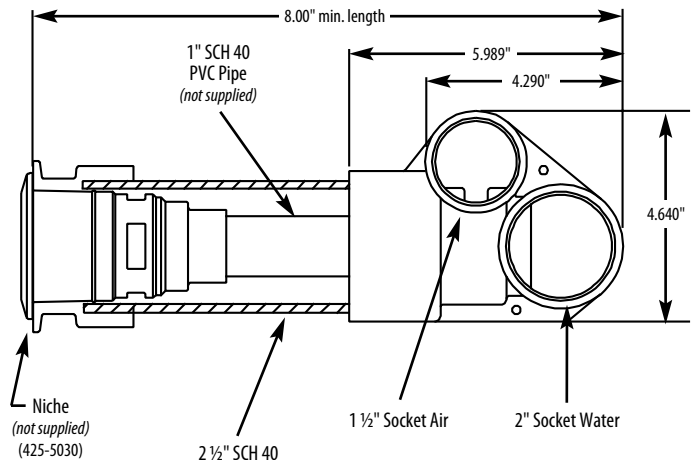

(instructions continued on back)

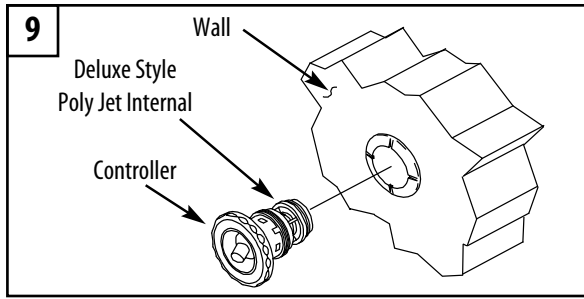

9. If installing a Deluxe Style internal, simply place into wallfitting and turn clockwise, hand tightening. When tight, turn counterclockwise to adjust to water flow.



To prevent personal injury, shock, or property/equipment damage, an Air Spring Check Valve (2" 600-8160, 1 1/2" 600-8140) must be installed on the blower stand pipe in case of a water backup in the air line.

Note: If a blower is not being used, please direct the air intake toward the ground using the 2" Sweep Vent Grate Assembly (400-4130) on the Air Inlet Pipe.

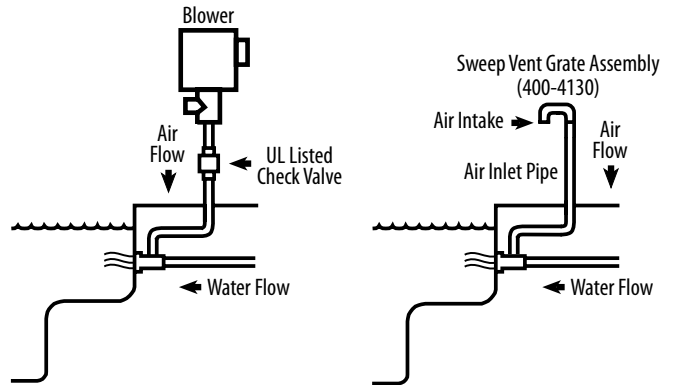

POLY JET INTERNALS AND ACCESSORIES



Always use at least one Non-Adjustable internal per spa to prevent deadheading pump.

STANDARD INTERNALS

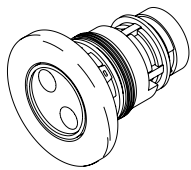

Adjustable
Pulsator
210-6060 - White
10 GPM

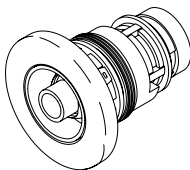

Adjustable
Roto
210-6120 - White
10 GPM

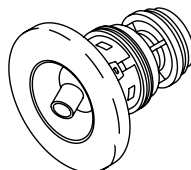

Adjustable
210-6100 - White
10 GPM

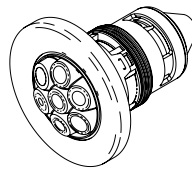

Adjustable
Massage (7 Nozzle)
210-6710 - White
10 GPM

NON-ADJUSTABLE

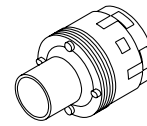

Whirlpool
210-9790
38 GPM

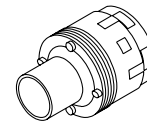

Monster
210-8750

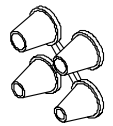

Four Different
Orifices Included
5/16" 10 GPM
3/8" 13 GPM
7/16" 17 GPM
1/2" 22 GPM

DELUXE SERIES

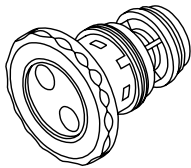

Adjustable
Pulsator
210-6070 - White
10 GPM

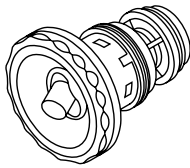

Adjustable
Roto
210-6090 - White
10 GPM

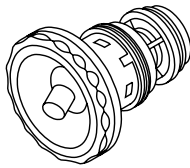

Adjustable
210-6080 - White
10 GPM

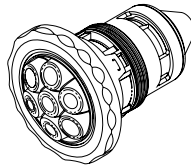

Adjustable
Massage (7 Nozzle)
210-6700 - White
10 GPM

ACCESSORIES



Handheld Jet
210-3200
10 GPM

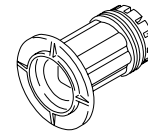

Wrench
218-1770

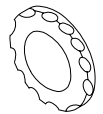

Stainless Steel
Trim Escutcheon
916-6000

WARRANTY

For product registration visit: www.waterwayplastics.com.
For Warranty questions or claims please contact point of purchase.



2200 East Sturgis Road, Oxnard CA 93030 • Phone 805.981.0262 • Fax 805.981.9403

www.waterwayplastics.com • waterway@waterwayplastics.com